

# SHIELD

## SHIELD S TOP CASE

### 用户说明书



FURCHTLOS

# CASE VARIANTS

## 尾箱型号 本说明书适用于所有SHIELD塑胶尾箱S号型号

### SHIELD S LUXE



FU02TCUP000S16EX



FU02TCUP000S14EX



FU02TCUP000S25EX

### SHIELD S



FU02TCXX000S16EX



FU02TCXX000S14EX



FU02TCXX000S25EX

# OPTIONAL ACCESSORIES

## 可选配件 以下是兼容SHIELD塑胶尾箱S号的可选配件（单独出售）

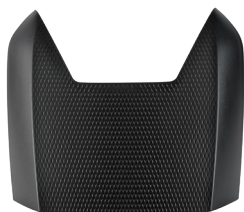

黑色彩盖  
FU02TCXX410001EX



白色彩盖  
FU02TCXX410002EX



舒适靠背  
FU02TCXX420001EX



银色彩盖  
FU02TCXX410004EX

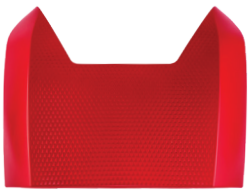

红色彩盖  
FU02TCXX410005EX

# PLATE COMPONENTS

## 底座部件

SHIELD尾箱S号标配以下尾箱底座部件

塑胶尾箱底座S号 x1

Plastic Support Plate



底座盖板 x2

Plastic Covers

塑料套筒 x4

Plastic Bushing

U型托架 x4

U Bracket

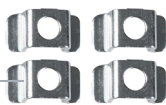

长螺丝 x4

Long Screw



W型托架 x4

W Bracket

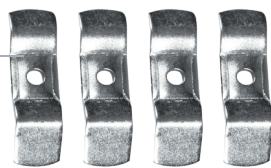

短螺丝 x4

Short Screw



垫圈 x4

Washers



螺母 x4

Nut

# TOOLS REQUIRED

## 所需工具

尾箱底座安装需自己配备以下工具

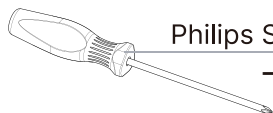

Philips Screwdriver

十字螺丝刀

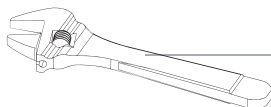

#10 Wrench

扳手 #10

# PLATE ASSEMBLY

## 底座安装流程

- 1 将尾箱底座放置于尾架所需位置，并在尾架上找到可以与尾箱底座上的孔洞对齐的4个固定点。



- 2 a) 如果固定点位于长槽位内，请将U型托架放置于长槽位内，并将其对准固定点。  
b) 如果固定点位于方形凹槽内，则将塑料套筒放置在该方形凹槽内。

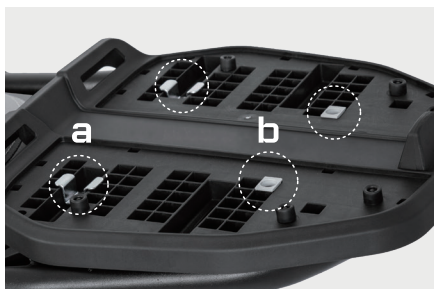

- 3 将螺丝插入相应孔位中。从尾架下方将垫圈和螺母放置于每颗螺丝的尾端，**根据不同尾架选择是否需要也将W型托架放置于垫圈与螺母的中间**。确认螺丝位置和长度合适后，从下方使用扳手固定螺母的同时，使用十字螺丝刀将4颗螺丝拧紧。确认尾箱底座已连接牢固，最后将底座盖板放置于尾箱底座顶部并向下按压直至到位。

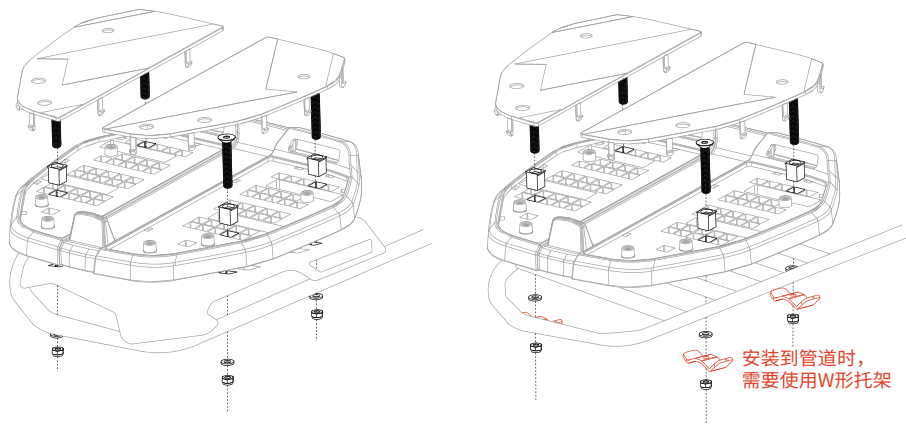

# 尾箱打开与关闭

- 1 打开尾箱时,请逆时针转动钥匙20度,解锁时箱盖会稍微向上弹起。解锁后,用手拉开箱盖以完全打开尾箱。

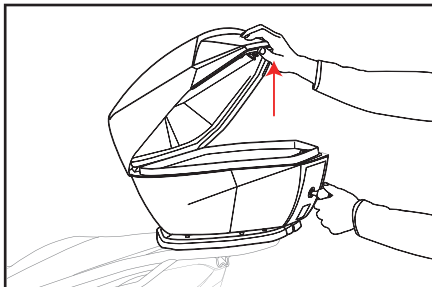
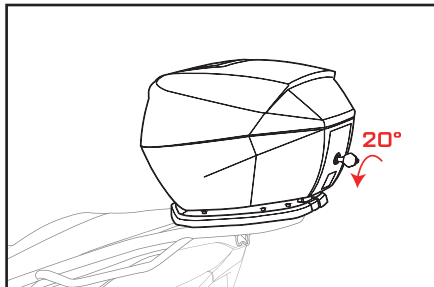

- 2 关闭箱子时,向下按压箱盖直到锁住

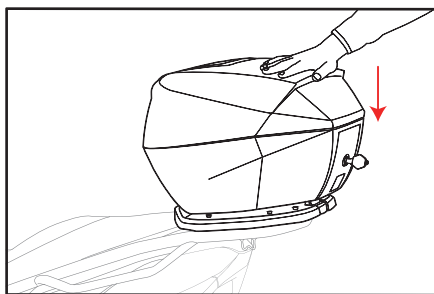

## 警告! WARNING!

请注意! 箱盖完全闭合后会自动锁死,请在合上箱盖前检查钥匙没有留在箱内!

Pay attention not to close the keys inside the case!

# 尾箱安装流程

- 1 安装尾箱之前,有必要安装兼容的S号塑胶尾箱底座(请参阅前面的说明)。

- 1 将尾箱的两个卡脚插入尾箱底座对应的孔洞中。

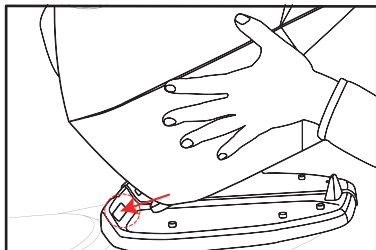
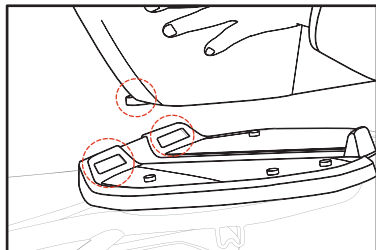

- 2** 插入钥匙并顺时针转动45度。

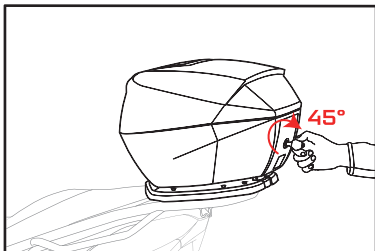
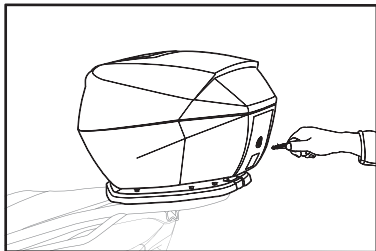

- 3** 按下安全锁下方按钮，并将尾箱前端放低，使底座上的楔子正确插入尾箱底部对应的凹孔内。松开按钮并检查连接是否稳固且箱子不会随意晃动。

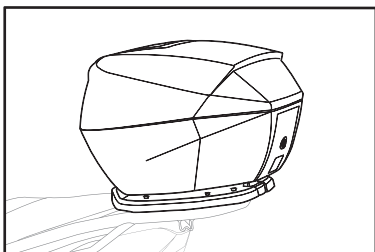
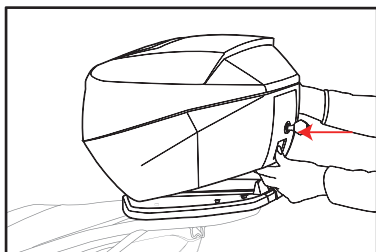

## REMOVING THE CASE

### 尾箱拆卸流程

- 1** 插入钥匙并顺时针转动45度。

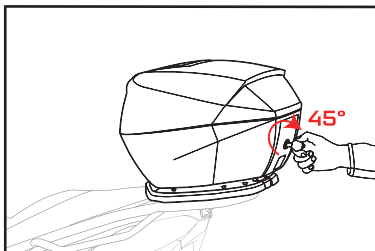
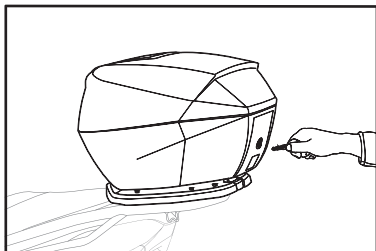

- 2** 按住位于底部的按钮并向上提起，即可拆下尾箱。

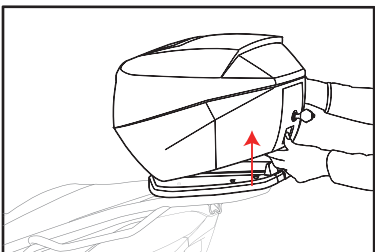
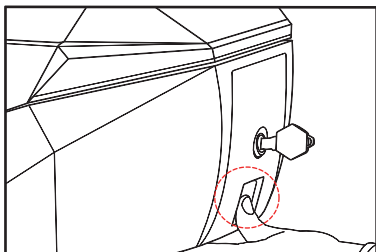

# WARNINGS AND GUIDELINES

## 警告和注意事项

### 使用警告 WARNING!

请参阅使用说明，了解正确的安装与保养说明。

Please read the user manual carefully and follow the recommended assembly and care instructions.

建议在每次操作摩托车之前检查箱子是否已连接牢固。

It's recommended to check that the case is securely attached before each operation of the motorcycle.

切勿在箱子超载、未上锁、未牢固连接或损坏等可能影响摩托车操作安全的情况下骑行。

Never drive the motorcycle with a case that is overloaded, that is not fully closed, that is not properly secured, or with damage that may affect the safe operation of the vehicle.

箱子禁止以及不应用于存放易燃易爆与易碎物品。

Please be mindful of how you pack your luggage. Cases should not be used to store flammable or explosive items or fragile items that can be easily broken.

### 清洁与保养注意事项 CLEANING & MAINTENANCE

清洁时只允许使用清水和温和的肥皂洗抹，并使用柔软的纺织布擦干。

The cases should only be cleaned with water and a mild soap and dried with a soft cloth.

请勿使用洗车洗涤剂或其他刺激性清洁剂或化学品进行清洁与保养。

Do not use car wash detergents or other harsh cleaning agents or chemicals.

请勿使用高压清洗机清洗。

Do not use a pressure washer.

当表面材料过长时间暴露在阳光直射下，或受到环境因素的影响时（如雾霾、酸雨等），可能会出现颜色变化或褪色现象。

When the surface material is exposed to direct sunlight for a long time or is affected by environmental factors (such as haze, acid rain, etc.), the color may fade or change.

产品沾染汽油或类似物质，必须立即清洁干净。

If the product is contaminated with gasoline or similar substances it must be cleaned immediately!

FURCHTLOS对清洁保养不当导致的产品损坏和颜色变化不承担任何责任。

FURCHTLOS does not assume any responsibility for product damage and color change caused by improper cleaning and maintenance!



只允许使用柔软的纺织布或  
海绵清水洗抹  
CLEAN WITH A DAMP CLOTH OR  
SOFT SPONGE



禁止使用高压清洗机  
DO NOT PRESSURE WASH



禁止使用过高粗糙度的清洁工具、  
强力清洁剂等  
DO NOT USE CHEMICALS OR HARSH  
CLEANING AGENTS



沾染汽油或类似物质必须  
立即清洁干净  
CLEAN GASOLINE OR OTHER  
SPILLS IMMEDIATELY!



视频教程  
VIDEO TUTORIAL



保修登记  
WARRANTY REGISTRATION



微信公众号  
FURCHTLOS WECHAT